

KOMATSU

HD605-10 mechanical truck



Photo may include optional equipment

Horsepower

Gross: 818 HP (610 kW)

Net: 791 HP (590 kW)

Nominal payload (standard body)

70.7 US tons (64.1 metric tons)

Body capacity

Heaped (SAE 2:1): 56.2 yd³ (43.0 m³)

Boosted productivity and efficiency

The HD605-10 rigid frame mechanical-drive haul truck is purpose-built with quarry, aggregate and mining customers in mind. This model maintains the legendary reliability and durability reputation experienced by customers around the globe while integrating modern operator comfort and technology features. It can quickly descend grades to the loading area and haul material to the dumping area in less time than the prior model due to reduced empty vehicle weight and increased engine horsepower.

High-performance Komatsu SAA6D170E-7 engine with 5.5% more horsepower and 9.5% more max torque than the prior model

- Larger radiator and demand fan
- High-efficiency, enlarged closed-loop cooling system
- Dual stage economy mode
- 1.9% increase in rated payload (+1.3 US tons/1.2 mt)
- 2.6% reduction in empty vehicle weight
- Maintains the tight turning radius (28'7"/8,712 mm) of the prior model

Keep your operation moving with this workhorse

- New dump body design with higher tensile strength steel
- Integrated payload meter system
- Adoption of the 10-10-20 payload policy
- Brake performance check procedure fully integrated in the machine monitor and Komtrax
- Maintenance-free batteries
- Lightweight resin wheel chocks

Stay in the know with Komtrax

The Komatsu wireless monitoring system lets you monitor all essential machine information on your computer, smartphone or tablet:

- Komtrax Plus data
- Satellite and wireless LAN access
- Insightful operational data and reports
- Data that empowers proactive preventative maintenance

Increased operator comfort

New features help reduce fatigue on long shifts

- Full LED light package provides excellent visibility for operation in variable conditions
- Waiting brake automatically applies the brake retarder when the shift lever is put in neutral, helping to reduce fatigue throughout the loading and dumping phases
- Hill start assist reduces potential rollback when starting from a stop on a slope
- Throttle lock enables the operator to set the engine speed for long uphill hauls
- Seat belt reminder system provides the operator with in-cab auditory and visual reminders when the belt is not fastened, and an externally mounted beacon indicates seatbelt status
- Automatic retard speed control (ARSC)
- Komatsu Traction Control System (KTCS)



Engineered for cost-efficiency and the environment

Komatsu's new emission regulation-compliant engine

Komatsu provides a powerful and economical U.S. EPA Tier 4 Final compliant engine with latest emission control technologies and fuel saving features.

- 1 Komatsu Diesel Particulate Filter (KDPF)
- 2 Variable geometry turbocharger (VGT)

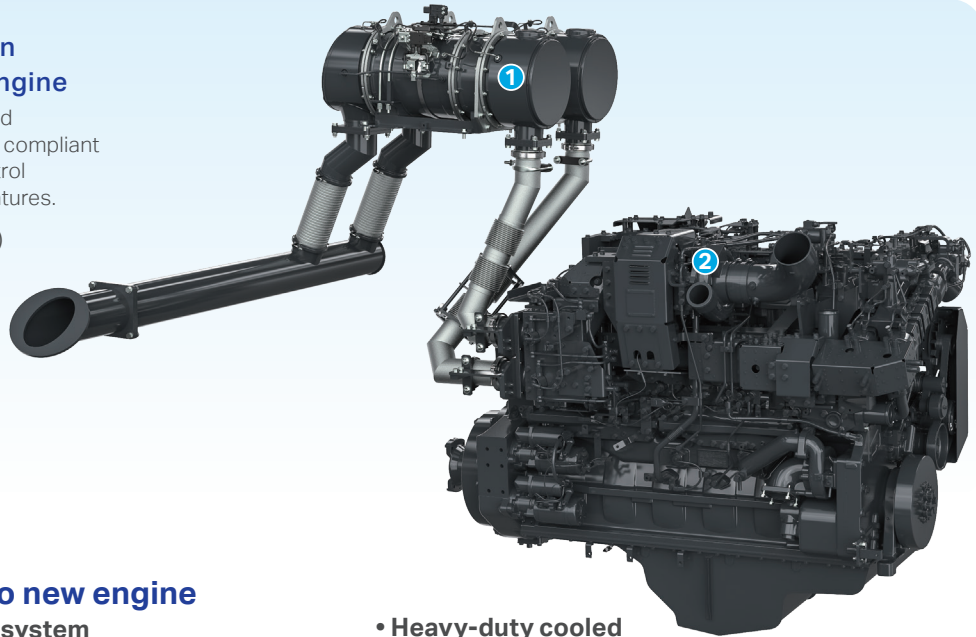

Technologies applied to new engine

• Heavy-duty aftertreatment system

The KDPF captures more than 90% of Particulate Matter (PM). Special oxidation catalyst and extra fuel injection in the exhaust stream can decompose accumulated soot in the DPF filter by either active or passive regeneration. This system does not require any additional operator's action or interrupt normal operation.

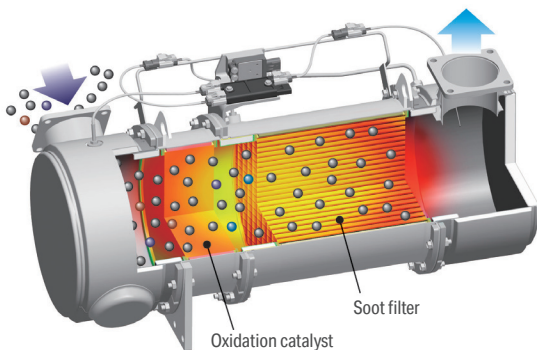

• VGT system

The system is designed to achieve an optimal injection of high-pressure fuel by means of computerized control, thereby bringing close to complete combustion to reduce PM emissions.

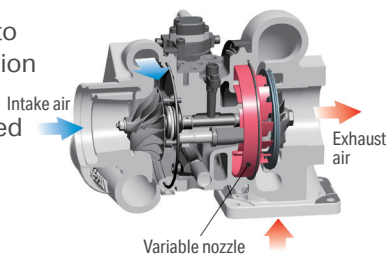

• Heavy-duty cooled exhaust gas recirculation (EGR) system

The system recirculates a portion of exhaust gas into the air intake and lowers combustion temperatures, thereby reducing NOx emissions. While EGR gas flow is increased, by incorporating a high-efficiency and compactly designed cooling system, the system achieves a dynamic reduction of NOx, while helping to reduce fuel consumption.

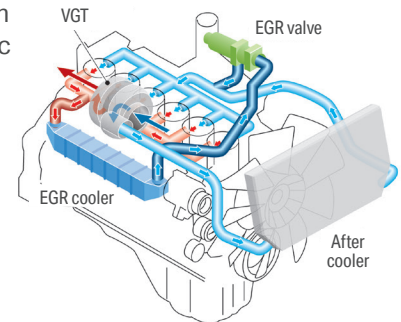

• High pressure common rail (HPCR) fuel injection system

The system is designed to achieve an optimal injection of high-pressure fuel by means of computerized control, thereby achieving near complete combustion to reduce PM emissions.

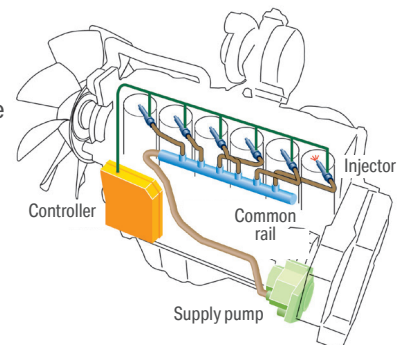

Electronic control system

The electronic control system performs high-speed processing of all signals from various sensors installed on the vehicle and the engine. This ensures effective integration of machine components. Engine condition is displayed on the monitor inside the cab, providing necessary information to the operator. Additionally, managing the information via Komtrax Plus helps customers schedule and track required maintenance actions.

Energy saving operation

In order to support optimum operation, an easy-to-read ECO gauge is included at the LCD unit of the machine monitor. The ECO gauge indicates a momentary fuel consumption rate during operation. Operating the vehicle with the gauge in the green zone ensures the most energy-efficient operation. (Fuel consumption rate depends on the application and the accelerator pedal operation.) In addition, the following ECO guidance messages are displayed for fuel-saving operation:

- Avoid long time engine idling
- Release the hoist lever
- Depressing accelerator pedal with brake actuated lowers fuel economy

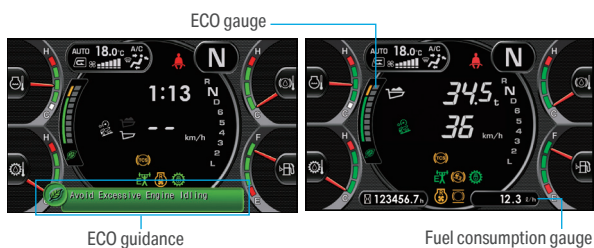

Lead-free radiator

Lead-free aluminum cores are used for the radiator to meet global environmental requirements.

Low fuel consumption

Latest Komatsu "on demand" energy saving technologies achieve lower fuel consumption while keeping high productivity.

- Variable displacement piston pumps for steering and hoist circuit
- Improvements in management of hydraulic pressure for transmission control

Auto idle stop

When the engine is idling for a certain time (able to be set from 5 to 60 minutes), the engine will automatically stop to reduce unnecessary fuel consumption and unwanted exhaust emissions.



Brake cooling oil recovery tank

In order to prevent environmental contamination, a tank is installed on each rear wheel to capture the oil in the event of brake cooling oil leakage from the floating seal.



Selectable operating modes

The operator can choose between three operating: "e light" mode, "economy" mode or "power" mode, according to machine operating condition or course profile.

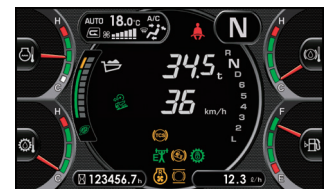

"Power" mode



The "power" mode increases the engine maximum power and raises the upshift and downshift engine speeds during operation.

"Economy" mode



The "economy" mode lowers the engine maximum power approximately 5% compared to P mode, along with lowering the upshift and downshift engine speeds during operation.

"E light" mode



The "e light" mode lowers the engine maximum power approximately 15% compared to "P" mode, along with lowering the upshift and downshift engine speeds during operation.

Productivity that can help you hit your targets

Rated horsepower

Increased by 5.5%

Maximum torque

Increased by 9.5%

Torque rise

Increased by 5%

(compared with HD605-8)

High performance Komatsu SAA6D170E-7 engine Upgrade

The powerful and fuel-efficient Komatsu SAA6D170E-7 engine on the HD605-10 delivers 818 HP at 2000 rpm, approx. 5.5% more than the previous model. This assures better acceleration and shorter cycle time for improved productivity. Torque rise is also 5% higher than the previous model, providing a powerful and stable ride and high productivity.

Power train components are redesigned to accommodate the increased power.

Engine gross horsepower: 818 HP



Fully hydraulic controlled wet multiple-disc brakes and retarder

Wet multiple-disc brakes ensure highly reliable and stable brake performance. The large-capacity, continuously-oil-cooled multiple-disc brakes also function as a highly responsive retarder. This gives the operator greater confidence at higher speeds when traveling downhill.

Retarder absorbing capacity: 1075.5 HP*

* At ambient temperature 104°F
Retarder performance varies depending on ambient temperature.

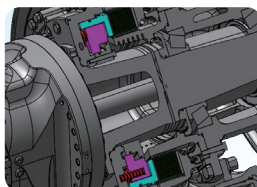

7-speed fully automatic transmission

The transmission is designed to have 7 forward and 1 reverse gears. Fully automatic control selects the optimum gear according to vehicle speed and the engine speed. The shift point automatically changes depending on the acceleration of the vehicle to minimize unnecessary fuel consumption.



Komatsu Advanced Transmission with Optimum. Modulation Control System (K-ATOMiCS) with skip shift function

K-ATOMiCS, electronic shift control with automatic clutch modulation in all gears, optimizes the clutch engagement oil pressure at every gear position is further improved and provides smoother shifting without torque off.

Skip shift function: Automatically selects a gear position depending on the slope grade when driving uphill without shifting down through each gear. It reduces the number of downshifts, makes the driving smoother, improves the operator's comfort and reduces material spillage.

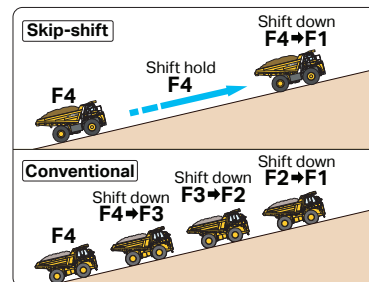

Long wheelbase and wide tread

With an extra-long wheelbase, a wide tread and an exceptionally low center of gravity, the HD605-10 hauls the load at higher speed for greater productivity, and delivers superior driving comfort over rough terrain.

Small turning radius

McPherson strut type front suspension has a special A-arm between each wheel and the main frame. The wider space created between the front wheels and the main frame increases the turning angle of the wheels. The larger turning angle provides a smaller turning radius for the truck.

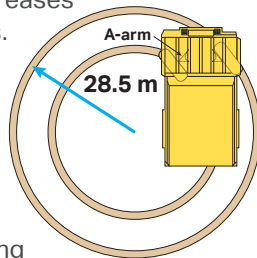

Minimum turning radius:
28.5 ft

(Turning radius varies depending on road conditions or vehicle speed.)

Automatic idling setting system

This system facilitates quick engine warm-up and operator cab cooling and warming. When setting the system ON, engine idle speed is kept at 1,100 rpm, but is lowered to 750 rpm when the coolant temperature rises. Speed automatically returns to 1,100 rpm when the coolant temperature drops.



Automatic retard speed control (ARSC)

ARSC allows the operator to easily set the downhill travel speed and go down slopes at a constant speed. As a result, this gives the ability to concentrate on steering. The speed can be set at an increment of ± 0.62 mph by clicking the control lever (3.1 mph) to adjust the downhill speed appropriate to the slope grade. The descent speeds of loaded and unloaded vehicles are recorded for automatic application later. This saves time and effort. The operator doesn't need to change the ARSC speed setting each time load status changes.



Komatsu Traction Control System (KTCS)

KTCS continuously monitors the rear wheels' rotating speed and vehicle speed for detecting slippage. If the system detects excessive wheel slip, it automatically applies the brake to control wheel slip ratio and maintain optimum condition of tire traction. As a result, KTCS improves productivity and tire life more than the conventional automatic spin regulator (ASR) system. KTCS is automatically activated and deactivated without operator interaction.

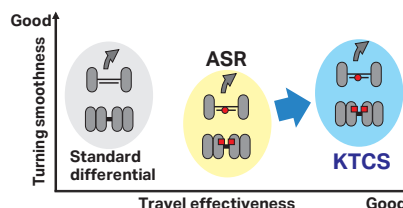

Built for operator comfort and efficiency



Ergonomically-designed cab

The ergonomically designed operator's compartment provides the operator a convenient control layout and comfortable environment for more confident operation and greater productivity.



Foldable trainer seat

The foldable trainer seat, with 2-point retractable seat belt, is comfortably sized.



Low-noise design

The spacious cab is mounted with large capacity viscous mounts. The low noise engine, hydraulically driven fan and the cab sealing provide a quiet, low vibration and comfortable operating environment.

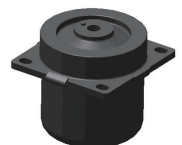

Noise level at operator's ear:
77 dB(A) (ISO 6396)

Waiting brake New

The brake retarder is automatically applied after machine is stopped and shift lever is in "n" position reduces the amount of brake lever operations during loading and dumping ("n" = neutral).

Throttle lock New

By pressing the control switch with the accelerator pedal depressed, the engine output is fixed even if the operator foot is off the pedal. This reduces the stepping operation on the accelerator pedal when climbing a slope. The throttle lock is automatically released when vehicle speed exceeds 18.6 mph, or the accelerator pedal or brake is operated.

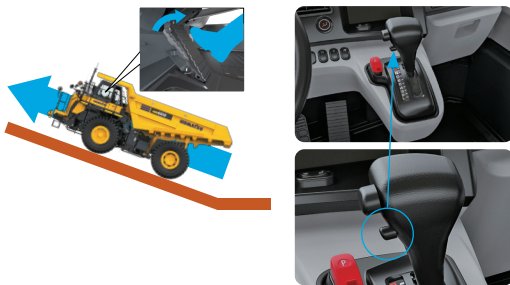

Hill start assist New

The brake is automatically applied when stopping on a slope. The brake is released once the accelerator pedal is pushed far enough to prevent the machine from rolling back. This makes the brake hold while the operator steps on the accelerator pedal, taking his foot off the brake until traction power has increased enough. Since the system automatically prevents the vehicle from sliding downwards when the operator moves his foot from the brake to the accelerator pedal on a slope, it makes it easier to control the vehicle, especially at start up.

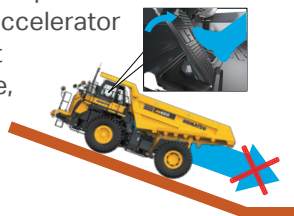

Air suspension seat

The fabric covered, air suspension operator seat is adjustable to the operator's weight. The air suspension dampens vibrations transmitted from the machine and reduces operator's fatigue. A seat heater is standard.

Dump lights (optional) New

The rear light and camera are activated during dumping, making confirmation of soil removal status at night easier.

Storage spaces

Generous storage spaces are provided inside the cab.

Glove box, lunch box tray, insulated storage and cup holder

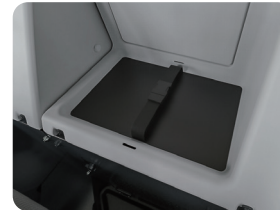

Lunch box tray



Hot or cool box, cup holder

High-performance radio Upgrade

The HD605-10 standard AM/FM radio includes connectionally via AUX and Bluetooth®.



Automatic climate control system

Automatic climate control system allows the operator to easily and accurately set the cab ambient temperature by the switch panel on the dash board. Excellent heating/cooling capacity and air flow keep the cab environment comfortable throughout the year.



Tilt-away and telescopic steering column

The tilting and telescoping steering column allows the operator to set the steering wheel to a desired position. The tilt mechanism incorporates a spring assist for easy adjustment and for operator seating and exiting.



Rearview monitor system

The operator can view the rear of the vehicle on the full color monitor, located on the right side of the dash board. This monitor can be always “on” or only when the shift lever is in the reverse position. Visual distance guidelines can be added for the operator’s convenience.



Rear view monitor



Rear view camera

Electronic hoist control

The electronically controlled hoist lever facilitates the dumping operation with light effort. A sensor is installed to detect the dump body position, and it significantly reduces the shock when the dump body is seated on the main frame.



DC12 V outlet

Two DC12 V outlets are standard in the operator’s cab. A 12 V cigarette lighter is located on the front side of the center console and an additional 12 V outlet is located on the rear cover behind the operator seat.

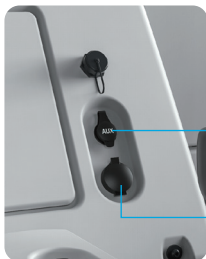

Cigarette lighter (DC12 V)
AUX terminal
DC12 V electrical outlet



Angled access stairs with handrails

The low angle of the front stairways provide easy access and egress to and from the machine.

Hydropneumatic suspension for all terrains

The hydropneumatic suspension provides a smoother ride over rough terrain to maximize production and operator comfort.

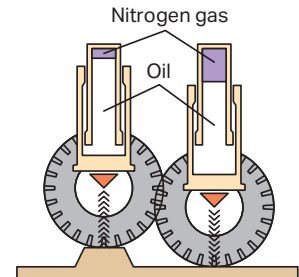

McPherson strut type front suspension

McPherson strut type independent suspension is used on the front wheels. The linkage arrangement with low friction allows the front wheel to follow uneven road surface smoothly for a comfortable ride.

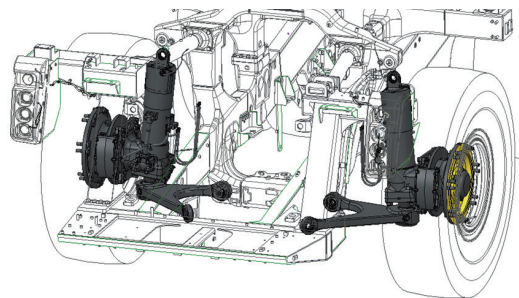
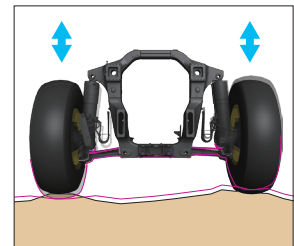

Dimpled slip-resistant plates

Stairways and walkways are made with dimpled, slip-resistant plates for better traction.



Dimpled slip-resistant plates

Built-in ROPS/FOPS cab

Operator cab structure conforms to ISO 3471 ROPS standard, and ISO 3449 FOPS Level II standard.



Secondary engine shutdown switch

The engine shutdown switch is located in the cab for emergency use.



LED rear combination lamps

LED lamps are standard for the rear combination lamps. The LED lamp features long service life, excellent visibility and energy-savings.



LED head lamps and LED fog lamps New

Standard LED head lamps and LED fog lamps improve safety and efficiency during night shift and also reduce service bulb replacement.



Speed limiter

The maximum travel speed is limited to a specific speed of both empty and loaded conditions independently.

Overload prevention system

The overload prevention system sounds an alarm when the payload exceeds the set value.

Secondary steering

The secondary steering system is automatically activated if the hydraulic pressure of the steering circuit lowers due to a failure in the hydraulic system. This can also be activated manually by the secondary steering switch in the cab. The pilot lamp on the LCD monitor tells the operator that the system is operable when turning the key switch on.



Conform to: ISO 5010, SAE J1511

Secondary brake

As an added measure of reliability, a secondary brake is standard. This system is operated by use of the left brake pedal and utilizes an independent hydraulic circuit to simultaneously apply the front brakes and rear parking brakes.



Conform to: ISO 3450, SAE J1473

Protection functions supported by electronic control

Item	Function
Downshift inhibitor	Even if the driver downshifts accidentally, transmission gear is kept until the vehicle speed becomes appropriate to the selected gear for preventing overruns.
Overrun inhibitor	When descending grades, if the vehicle's speed surpasses the maximum speed for the current gear, the rear brakes are automatically activated, preventing overruns.
Reverse inhibitor	The vehicle is prevented from shifting to reverse gear when operating the body.
Forward/reverse shift inhibitor	This device prohibits damaging shifting (forward or reverse) when the vehicle's speed exceeds 2.5 mph (4 km/h).
Anti-hunting system	When running near the shift point, eliminate unnecessary shift up and down for smooth traveling.
Neutral safety	The engine is prevented from starting when the shift lever is not in neutral.
Neutral coast inhibitor	It prevents gear position from shifting to neutral while traveling over a certain speed, even if the shift lever is moved to neutral position.

Information and communication technology (ICT)

High resolution 7-inch color LCD unit

The machine monitor displays various machine information and allows for various settings. 7-inch color LCD unit displays various machine information in the normal screen. By using the switch panel, the screen can be changed to the user menu screen. The switch panel is also used to control the air conditioner.

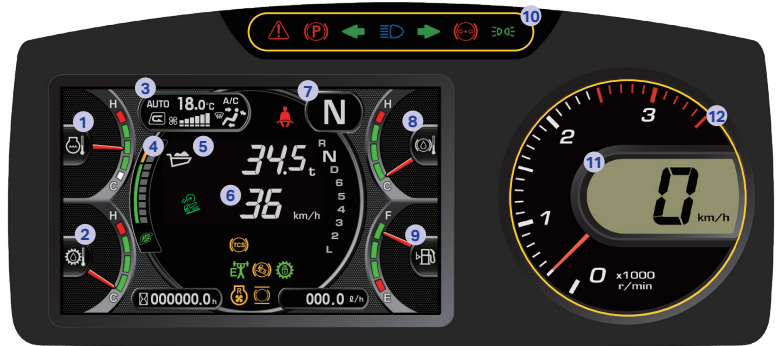

Switch panel

- 1 Air conditioner (A/C) switches/ numeral key pad
- 2 Function switches



Machine monitor

- 1 Engine coolant temperature gauge
- 2 Torque converter oil temperature gauge
- 3 A/C display
- 4 ECO gauge
- 5 Payload/clock
- 6 ARSC set travel speed
- 7 Shift indicator
- 8 Retarder oil temperature gauge
- 9 Fuel gauge
- 10 LED indicator
- 11 Speedometer
- 12 Engine tachometer

Maintenance time caution

When the time to the next maintenance action is less than the preset hours*, the maintenance time monitor appears.

* The time can be set in the 10 to 200 hours range.



Maintenance screen

Troubleshooting function

Various meters, gauges and warning functions are centrally arranged on the LCD unit. This unit facilitates the start-up inspection and promptly warns the operator with a lamp and a buzzer if any abnormal conditions occur. Each abnormal condition is indicated according to one of four recommended action levels.



Visual user menu

Pressing the menu switch on the switch panel displays the user menu screen. The menus are grouped by their functions. Easy-to-understand icons enable intuitive use.

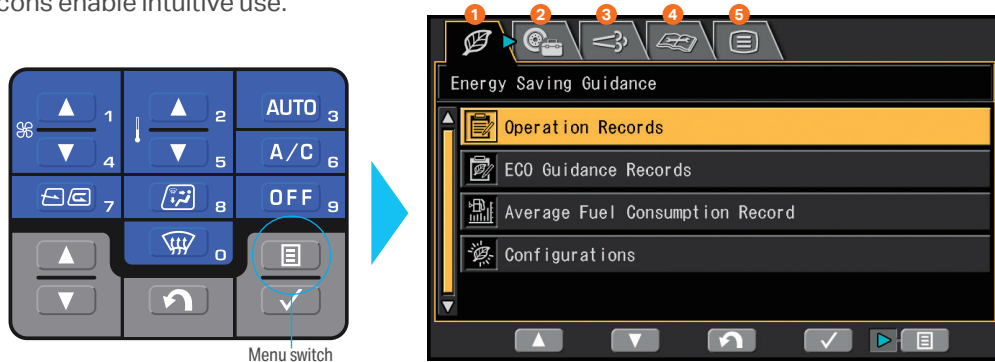

1 Energy saving guidance

- Operation records
- ECO guidance records
- Average fuel consumption record
- Configurations

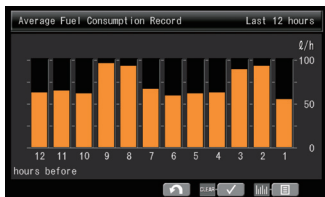
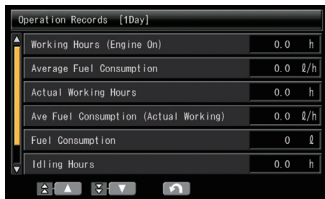

2 Machine setting/information

- Radiator fan reverse mode
- KTCS setting etc.

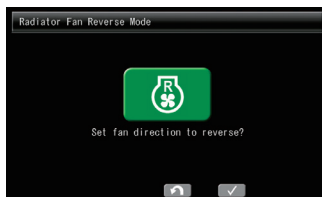
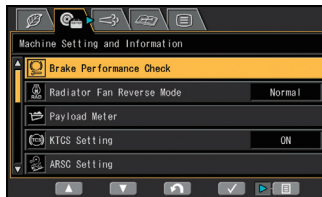

3 Aftertreatment devices regeneration

- Setting regeneration disable
- Operation of manual stationary regeneration

4 Maintenance

Check and reset of various maintenance remainings

Maintenance	Interval	Remain
Air Cleaner Cleaning or Change	—	—
Engine Oil Change	500 h	500 h
Engine Oil Filter Change	500 h	500 h
Fuel Prefilter Change	500 h	500 h
T/M Oil Filter Change	500 h	500 h

5 Monitor setting

- Language setting (27 languages)
- Rear view monitor setting
- Measurement unit setting
- Screen brightness adjustment etc.



Brake performance check New

The procedure for each brake performance check (foot, parking, secondary, and retarder brake) is displayed on the screen. The results of checks will be displayed as "normal" or "degraded." The secondary brake should be checked before every job. A reminder is displayed to make sure it is done.

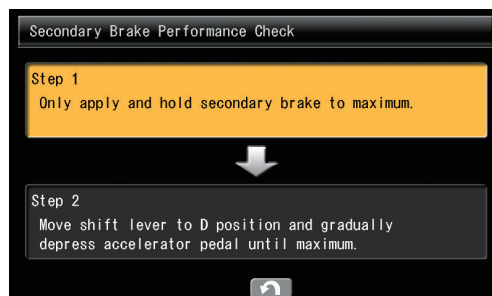

Designed for reliable performance

High-rigidity frame

Cast-steel components are used in critical areas of the main frame where loads and shocks are most concentrated.

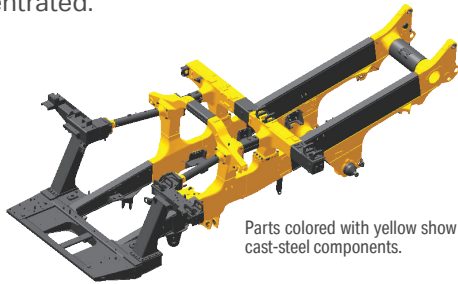

Parts colored with yellow show cast-steel components.

Robust dump body design

The general purpose dump body is made of high-tensile-strength steel for excellent rigidity and low maintenance cost. The V-shape and V-bottom design contribute to the structural strength. The side and bottom plates of the dump body are reinforced with lateral and longitudinal bolsters. General purpose body capacity is increased to 56.2 yd³ (43 m³) — 8% greater than the current model HD605-8.

Payload meter (PLM)

PLM is a tool to manage the payload of each hauling cycle and to analyze the production volume and the working conditions of the dump truck for a specified period of time. Loaded weight is indicated on the payload display (On the LCD unit) and by the external display lamps in real time while loading.



External display lamp



Payload display — Loaded weight

Loading policy

Each dump truck has its own “target payload.” Following the “Loading Policy” results in maximizing the productivity by full utilization of the vehicle performance, reducing the operating cost, and extending the life of brakes, tires and other components.

1. Monthly average payload must not exceed the target payload of the truck.
2. No less than 90% of all loads must be up to 110% of the target payload of the truck.
3. No more than 10% of all loads may be between 110% and 120% of the target payload of the truck.
4. Any single load must not exceed 120% of the target payload of the truck.

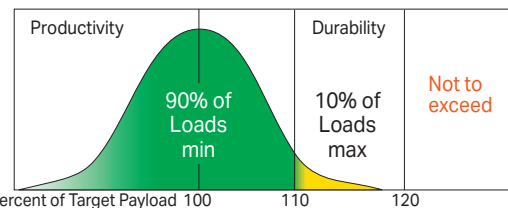

Target payload: Rated gross vehicle weight - Empty vehicle weight (Include all attached options)

Operating a dump truck with an extraordinary payload causes the following adverse effects.

- Operating an under loaded truck cannot fully utilize the vehicle performance and increases the number of round trips required to haul the same quantity of materials, resulting in increased cost-per-ton.
- Operating an overloaded truck causes early wear of brake discs, tires, etc., and shortens the life of components such as drive system etc. resulting in increased maintenance and repair costs.

Body selection

A general purpose body and optional liner are available for the HD605-10.

General purpose body

This body is designed for general purpose. Major portions of this body are made of abrasion resistant steel plates to assure high durability.

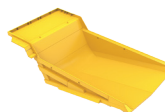

General purpose/steel liners

This rock body is made by attaching liner plates to the general purpose body. Recommended use of this body is carrying relatively large size rocks or highly abrasive material.

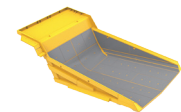

Bottom	t16 / SAR(450 HB)	t16 / SHT560
Front	t9 / SAR(450 HB)	t9 / SHT560
Side	t9 / SAR400	t9 / SHT560
Canopy	t9 / SAR400	—
Capacity	56.25 yd ³ (43.0 m ³)	55.2 yd ³ (42.2 m ³)

Built for ease of maintenance

Centralized arrangement of filters

The filters are centralized for easy service.



Electric circuit breaker

Circuit breakers are used for important electric circuits that need to be restored quickly when a problem occurs in the electrical system.



Centralized greasing points

Greasing points are located to be accessible from ground level. Centralized greasing points at three locations makes daily maintenance easier.



Electric priming pump

Electric engine priming pump is standard.



Maintenance-free battery New

Maintenance-free battery saves maintenance time. Operator needs only to check the indicator to know the status (OK/Charge/Replace).



Battery disconnect switch

For machine service work, a battery disconnect switch is located on the right side of the vehicle, and accessible from ground level.



Long oil change intervals

Long oil change intervals minimize operating cost.

- Engine oil 500 hours
- Hydraulic oil 4,000 hours
- Transmission oil 1,000 hours

Reversible fan

The radiator fan is hydraulically driven and reversible. The fan reverse mode can be controlled by use of the monitor.

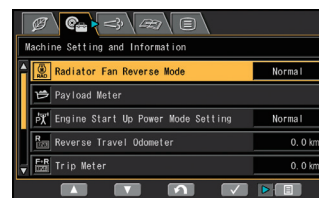

Fan reverse indicator

Modular radiator core system

The radiator assembly consists of two cores, and each core can be independently replaced without removing the entire assembly.

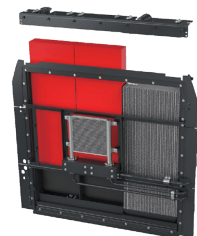

Plastic wheel chocks New

Weight of a plastic wheel chock is about 13.9 lbs and much lighter than a steel or wooden wheel chock. It is enough light to carry a plastic wheel chock with one hand.



Specifications

Engine

Model	Komatsu SAA6D170E-7	
Type	Water-cooled, 4-cycle	
Aspiration	Variable geometry, turbo-charged, air-to-air after-cooled, cooled Exhaust Gas Recirculation (EGR)	
No. of cylinders	6	
Bore	6.69 in	170 mm
Stroke	6.69 in	170 mm
Piston displacement	1,413 in ³	23.15 L
Engine power		
SAE J1995	Gross 818 HP (610 kW) @ 2,000 rpm	
ISO 14396/SAE J1995	Net 791 HP (590 kW) @ 2,000 rpm	
Fan drive type	Hydraulic	
Maximum torque	3,016 ft.-lbs.	417 kgf-m
Fuel system	Direct injection	
Governor	Electronically controlled	
Lubrication system		
Method	Gear pump, force-lubrication	
Filter	Full-flow type	
Air cleaner	Dry type with double elements, pre-cleaner and evacuator valve	

Transmission

Torque converter	3-elements, 1-stage, 2-phase	
Transmission	Fully automatic, planetary type	
Speed range	7 speeds forward and 1 reverse	
Lockup clutch	Wet, multiple-disc clutch	
Forward	Torque converter drive in 1st gear, direct drive in 1st lockup and all higher gears	
Reverse	Torque converter drive	
Shift control	Electronic shift control with automatic clutch modulation in all gears	
Maximum travel speed	43.5 mph	70.0 km/h

Axles

Rear axle	Full-floating	
Final drive type	Planetary gear	
Ratios		
Differential	3.538	
Planetary	4.737	

Suspension system

Independent, hydropneumatic suspension cylinder with fixed throttle to dampen vibration		
Effective cylinder stroke (front suspension)	11.9 in	303 mm
Rear axle oscillation		
Oil stopper	6.8 in	173 mm
Mechanical stopper	7.7 in	196 mm

Steering system

Type	Fully hydraulic power steering with two double-acting cylinders	
Supplementary steering	Manually controlled	
Minimum turning radius	28ft. 7 in	8.7 m
Maximum steering angle	39 degrees	

Cab

Dimensions comply with ISO 3471 ROPS (rollover protective structure) standards

Brakes

Brakes meet ISO 3450 standards

Service brakes

Front	Dry type, single disc type full hydraulic	
Rear	Oil-cooled, multiple-disc type full hydraulic	
Parking brakes	Oil-cooled, multiple-disc type, spring operated, hydraulic releasing type	
Retarder	Oil-cooled, multiple-disc type full hydraulic	
Secondary brake	Manual pedal operation when hydraulic pressure drops below the rated level, parking brake is automatically actuated	

Main frame

Type	Box-sectioned structure	
------	-------------------------	--

Hydraulic system

Hoist cylinder	Twin, 2-stage telescopic type	
Relief pressure	2,988 psi	20.6 MPa 210 kgf-cm ²
Hoist time	11.5 sec	

Tires

Standard tires	24.00 R35
----------------	-----------

Service refill capacities

Fuel tank	211.3 gal	800 L
Engine oil	21.1 gal	80 L
Torque converter, transmission and retarder cooling	59.2 gal	224 L
Differential	25.1 gal	95 L
Final drives (total)	11.1 gal	42 L
Hydraulic system	39.4 gal	149 L
Suspension (total)	17.5 gal	66.2 L

Body

General purpose body

		Unlined (standard)		Lined	
Capacity	Heaped capacity (2 : 1)	56.2 yd ³	43 m ³	55.2 yd ³	42.2 m ³
	Struck capacity	42.2 yd ³	32.3 m ³	41.1 yd ³	31.4 m ³
Target area		31.5 yd ² / 26.3 m ² (21'10" / 6,650 mm × 13' / 3,960 mm)			
Weight	Empty weight	110,893 lbs.	50,300 kg	120,152 lbs.	54,500 kg
	Nominal payload*	141,316 lbs.	64,100 kg	132,057 lbs.	59,900 kg
	Gross vehicle weight	252,209 lbs.	114,400 kg	252,209 lbs.	114,400 kg
	Maximum payload (120 %)	169,579 lbs.	76,900 kg	158,468 lbs.	71,900 kg
	Max. gross vehicle weight (120 %)	280,428 lbs.	127,200 kg	278,664 lbs.	126,400 kg
	Distribution (empty)	Front	54.2%		51.1%
	Rear	45.8%		48.9%	
Distribution (loaded) *nominal	Front	33.6%		33.5%	
	Rear	66.4%		66.5%	
Body (liner) thickness	Bottom	.63"	16 mm	.63"	16 mm
	Front	.35"	9 mm	.35"	9 mm
	Side	.35"	9 mm	.35"	9 mm
Body material	Bottom and front	450 HB high tensile strength steel			
	Side	400 HB high tensile strength steel			

*Payload may vary depending on the machine and body configuration. Please contact distributor for details regarding your specific configuration.



Dimensions

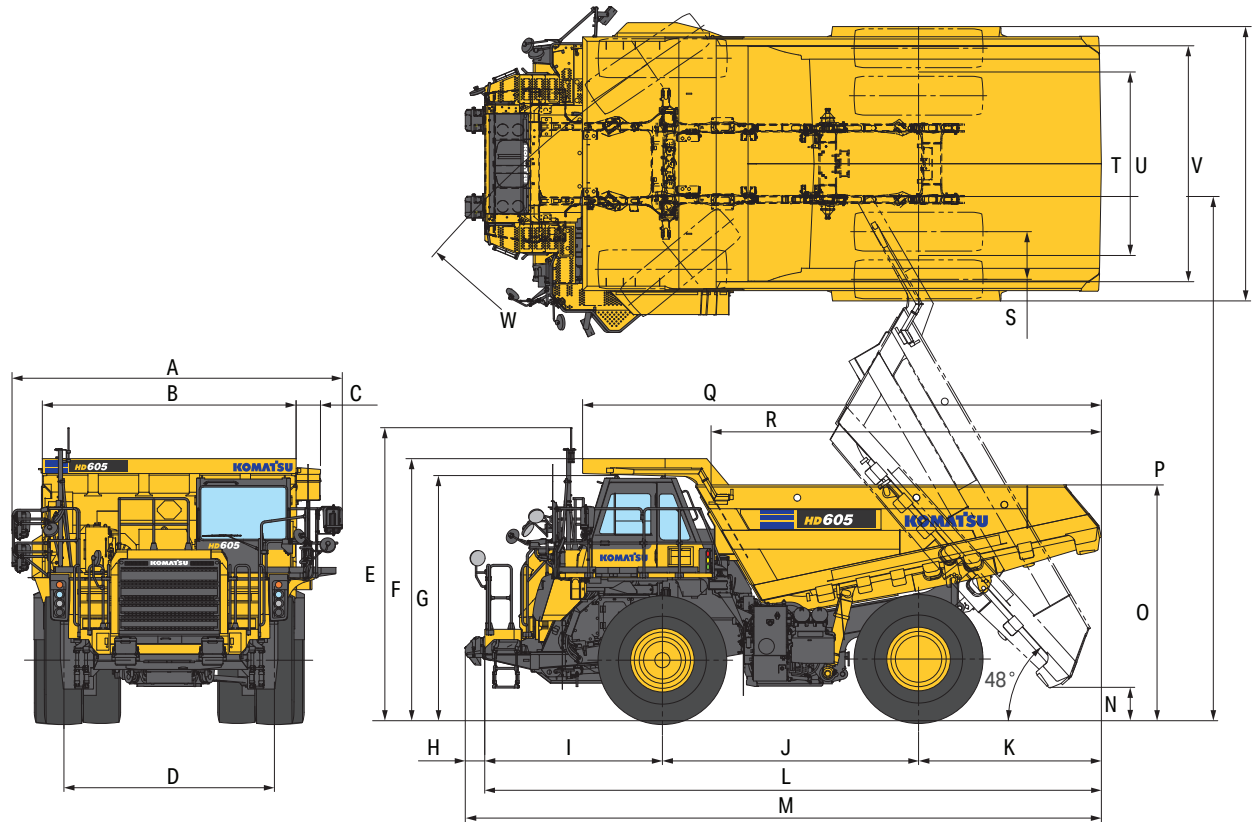

Machine dimensions

A	Overall width	18' 2" (5,545 mm)
B	Body shipping width	13' 11" (4,260 mm)
C	Cab guard width	1' 3" (403 mm)
D	Track width (front)	11' 7" (3,535 mm)
E	Overall height	16' 2" (4,920 mm)
F	Body height	14' 5" (4,400 mm)
G	Height to top of ROPS	13' 6" (4,115 mm)
H	Wheelchock length	1' 1" (330 mm)
I	Front tire to bumper length	9' 9" (2,980 mm)
J	Wheelbase	14' 1" (4,300 mm)
K	Rear axle to tail	10' 1" (3,070 mm)
L	Overall length (without wheelchocks)	33' 11" (10,350 mm)

M	Overall length (with chocks)	35' (10,680 mm)
N	Dump clearance	1' 10" (560 mm)
O	Loading height (empty)	13' (3,960 mm)
P	Height with body up	28' 10" (8,800 mm)
Q	Overall body length	28' 7" (8,710 mm)
R	Inside body length	21' 9" (6,635 mm)
S	Rear tire spacing	2' 7" (795 mm)
T	Track width (rear)	10' 1" (3,080 mm)
U	Inside body width	13' (3,960 mm)
V	Overall tire width	15' 1" (4,605 mm)
W	Minimum turning-radius	28' 8" (8,730 mm)

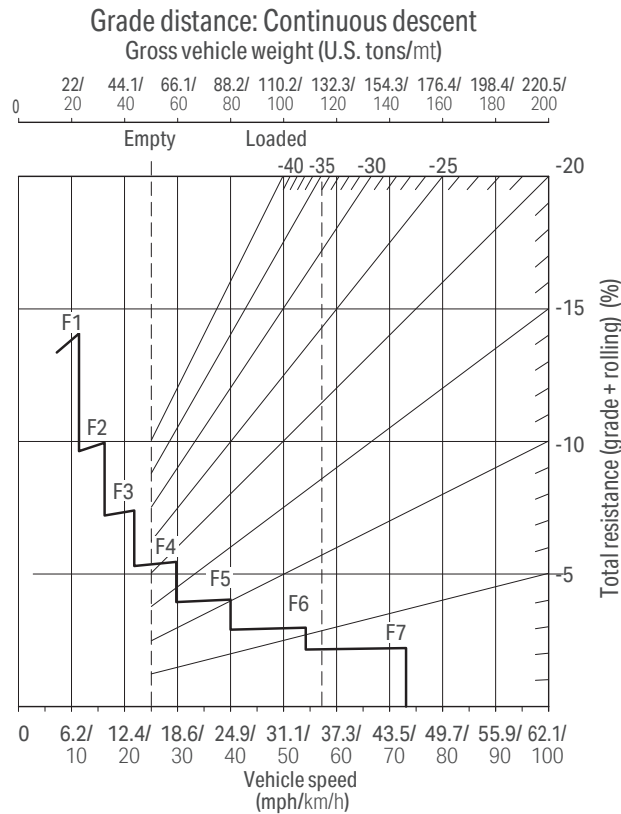
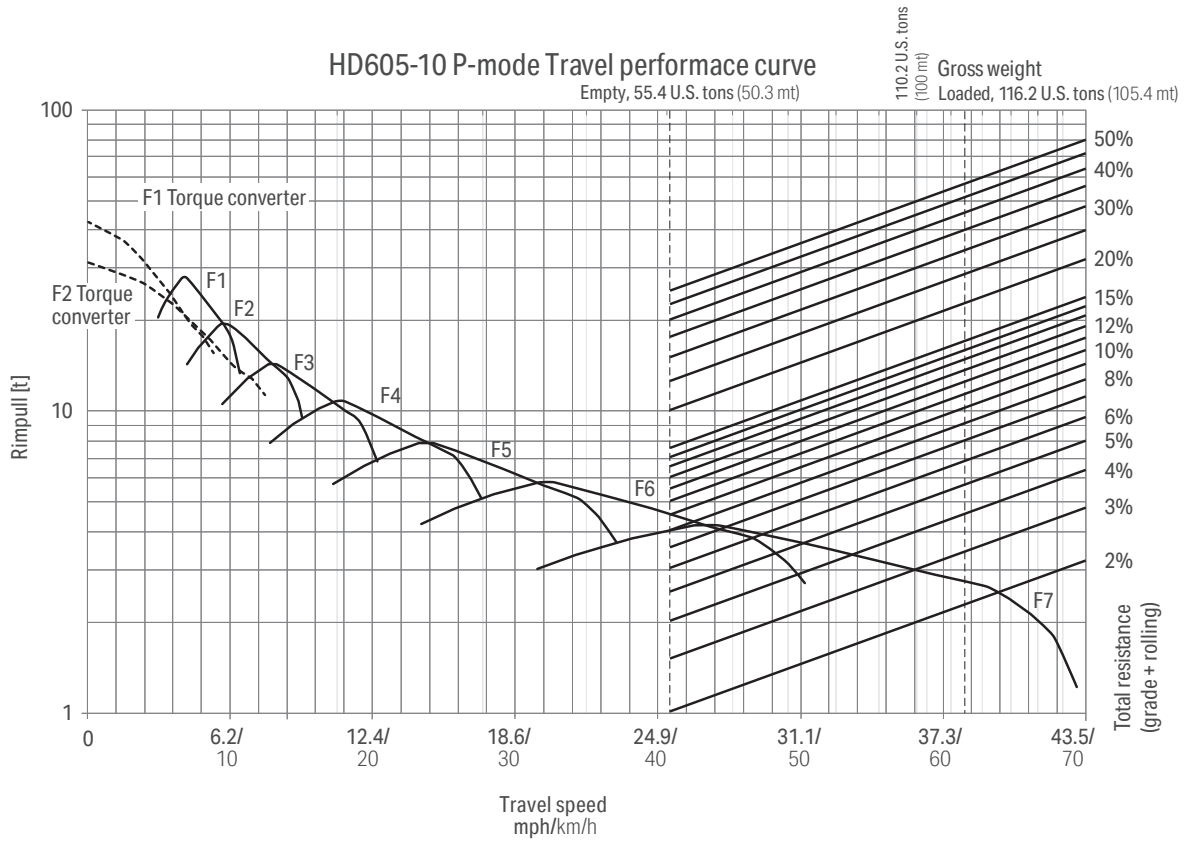

At ambient temperature 104 °F/40 °C
 Retarder performance varies depending on ambient temperature.

Equipment

Engine and related components

Air cleaner, dry type, two stage	●
Auto idle shutdown	●
Automatic idling setting system (AISS)	●
Biodiesel fuel, B20	●
Body heat exhaust	●
Electric priming fuel pump	●
Engine, Komatsu SAA6D170E-7, 6-cylinder, turbocharged, air/air aftercooled, EGR cooled, diesel	●
Gross HP (SAE J1995): 818 HP (610 kW) @ 2,000 RPM	●
Net HP (ISO 9249/SAE J1349): 791 HP (590 kW) @ 2,000 RPM	●
Engine secondary shutdown switch	●
Fan, hydraulically driven, reversible	●
Komatsu Diesel Particulate Filter (KDPF) (qty. 2)	●
Mode selector switch (Power, Economy, Economy lite)	●
Radiator, lead-free, modular core	●

Electrical system

Alternator, 100 ampere, 24 volt	●
Back-up alarm	●
Batteries, maintenance free, 4 x 12 volt, 160 Ah	●
Battery disconnect switch	●
Electric circuit breakers, 24V	●
Emergency stop switch, ground level	●
Horn, electric	●
Lights	●
Beacon lamp, amber	●
LED access ladder lamp	●
LED back-up lamp, rear	●
LED dump lamp	●
LED engine compartment lamp	●
LED fog lamps	●
LED head lamps, high and low beam	●
LED side working lamps, LH and RH	●
LED stop and tail lamps	●
LED turn signal/hazard warning, front and rear	●
Starter disconnect switch	●
Starting motors, 2 x 7.5 kW direct electric 24-volt	●

Power train and controls

7-speed transmission, fully automatic with K-ATOMiCS	●
Brake cooling oil recovery tank	●
Front brake, caliper disc-type	●
Komatsu Traction Control System (KTCS)	●
Parking brake, integrated in rear brake	●
Rear brake, oil cooled, multiple disc, hydraulically controlled	●
Secondary brake, pedal actuated, variable	●
Skip shift function	●
Speed limiter	●

Operator environment

Cab with built-in ROPS/FOPS	●
12 volt outlet (qty. 2)	●
Automatic climate control system with cab pressurization	●
Body hoist control, electric	●
Cigarette lighter, 12-volt and ashtray	●
Dome light	●
Door, LH and RH	●
Lunch box and beverage holder	●
Machine monitor with 7-inch color LCD display	●
Operator seat, air suspension type, heated, ventilated with 3-point retractable seat belt (3" (75 mm) wide lap belt, 2" (50 mm) wide shoulder belt)	●
Power window, LH and RH	●
Radio, AM/FM with AUX, USB and Bluetooth inputs	●
Rear window electronic defrost	●
Rearview mirror, outside cab mount, heated (LH & RH)	●
Rearview monitoring system, dedicated monitor	●
Secondary steering system	●
Steering wheel, tilt and telescopic	●
Sun visor, screen	●
Tinted glass (Front: laminated glass)	●
Trainer seat, folding, with 2-point retractable seat belt (3" (75 mm) wide)	●
Underview mirror	●
Wiper/washer front and rear, front intermittent	●

Guard and cover group

Cab and platform guards	●
Catwalk with handrails, skid resistant	●
Driveline guards, front and rear	●
Engine underguard	●
Exhaust side covers	●
Exhaust thermal guard	●
Mud flaps	●
Rock ejector bar	●
Transmission underguard	●

Standard equipment	●
Optional equipment	○

Other

Alternative exhaust configuration (RH side discharge)	○
Anchor points, tie-off type (ISO 14567)	●
Angled front stairs with handrails	●
Automatic retard speed control (ARSC)	●
Bridgestone VRLS tires	○
Centralized greasing points	●
Dump counter	●
Ecology guidance and ecology gauge	●
Fast fill coupler for fuel tank	●
Filler cap and cover lock	●
Front brake cut-off system	●
Haul road analysis system	●
Hill start assist	●
Hydropneumatic suspension (front and rear)	●
Komtrax Plus telematics package with integrated payload meter (PLM), satellite communication and Wireless LAN	●

KOWA sampling ports	●
Lined dump body	○
Machine immobilization switch	●
Michelin XTRA Load Grip tires	○
Overload prevention alarm	●
Overrun warning and prevention	●
Overturn warning system	●
PM service connectors	●
Rims for 24.00 R35 tires (qty. 6)	●
Safety pins (qty. 2)	●
Seatbelt beacon harness	●
Unlined dump body	○
Wheel chock, resin, with storage bracket (qty. 2)	●

Standard equipment ●

Optional equipment ○



Notes

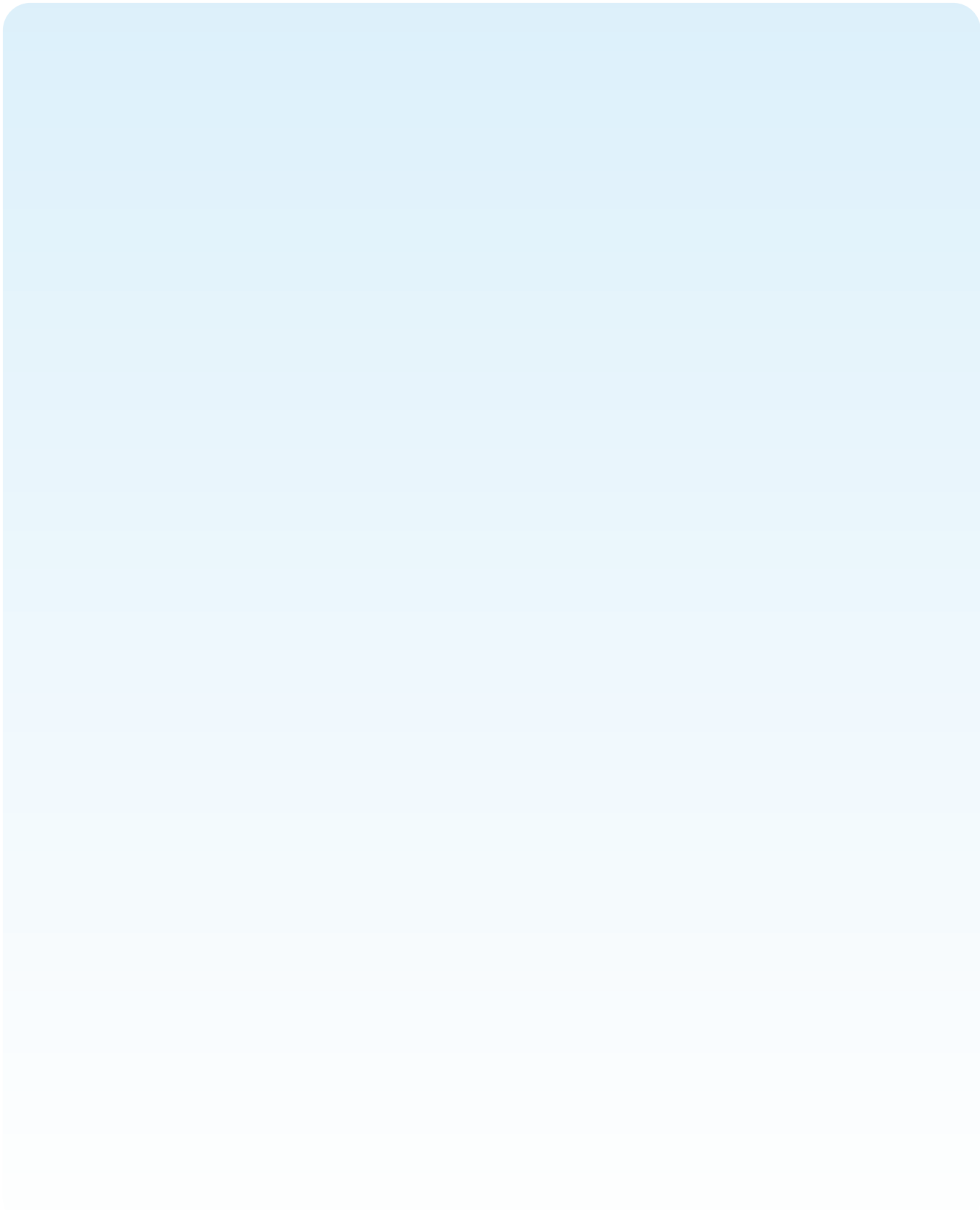

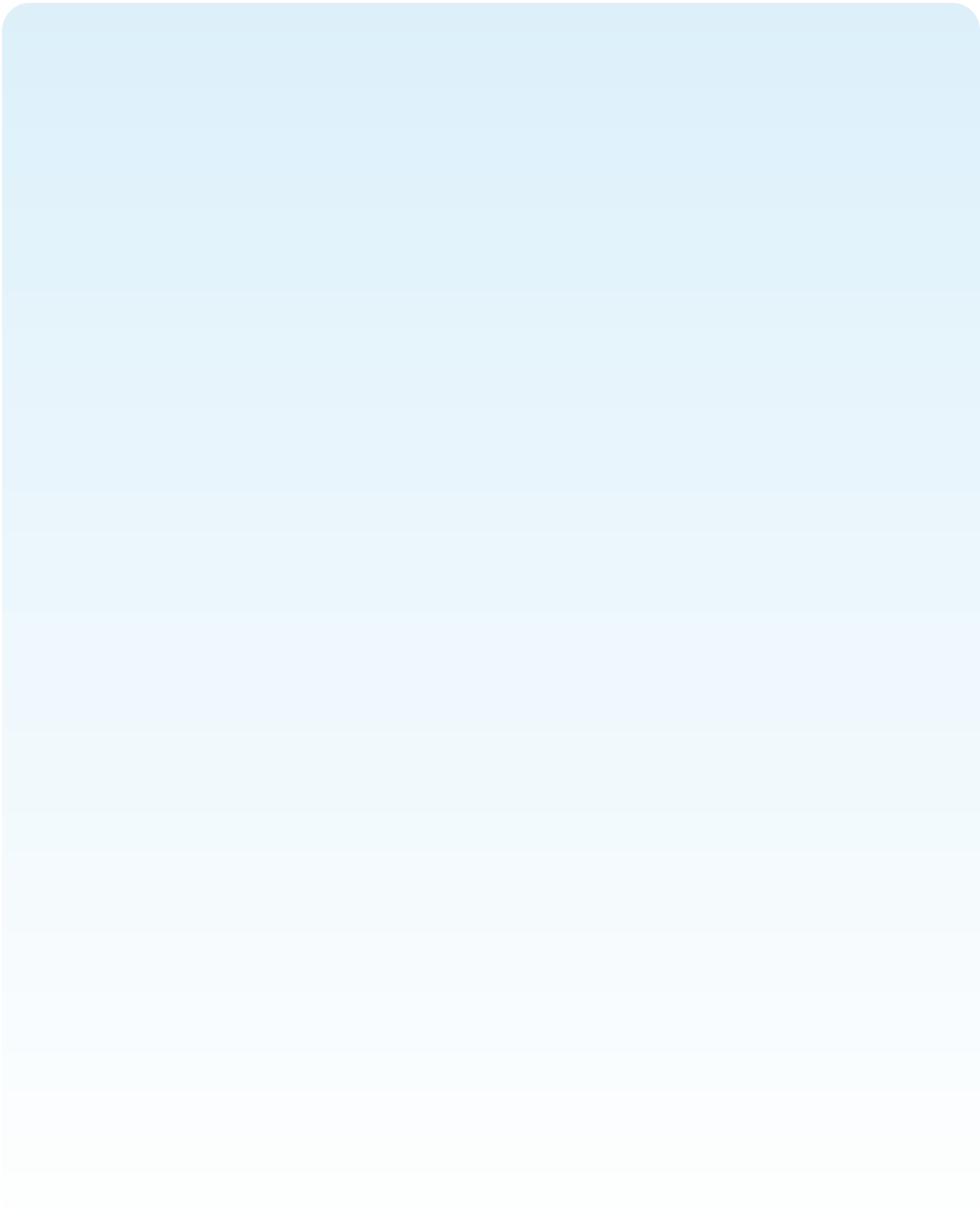

Product designs, specifications and/or data in this document are provided for informational purposes only and are not warranties of any kind. Product designs and/or specifications may be changed at any time without notice. The only warranties that apply to sales of products and services are Komatsu's standard written warranties, which will be furnished upon request.

Komatsu and other trademarks and service marks used herein are the property of Komatsu Ltd. or its subsidiaries, or the respective owners or licensees.

KOMATSU

[komatsu.com](https://www.komatsu.com)

